

Ryttons A1® Fire-rated Retrofit Ducting Kit 204mm x 60mm with Return Grille Single Air Brick Flanged
Custom RAL colour air brick in matt, semi-gloss or gloss finish achieving Class A2-s1, d0
RAL1019 (Grey beige) matt finish pictured
Registered Design 6085466
Patent Approved
Product Code: A1RFDK204X60RGSF

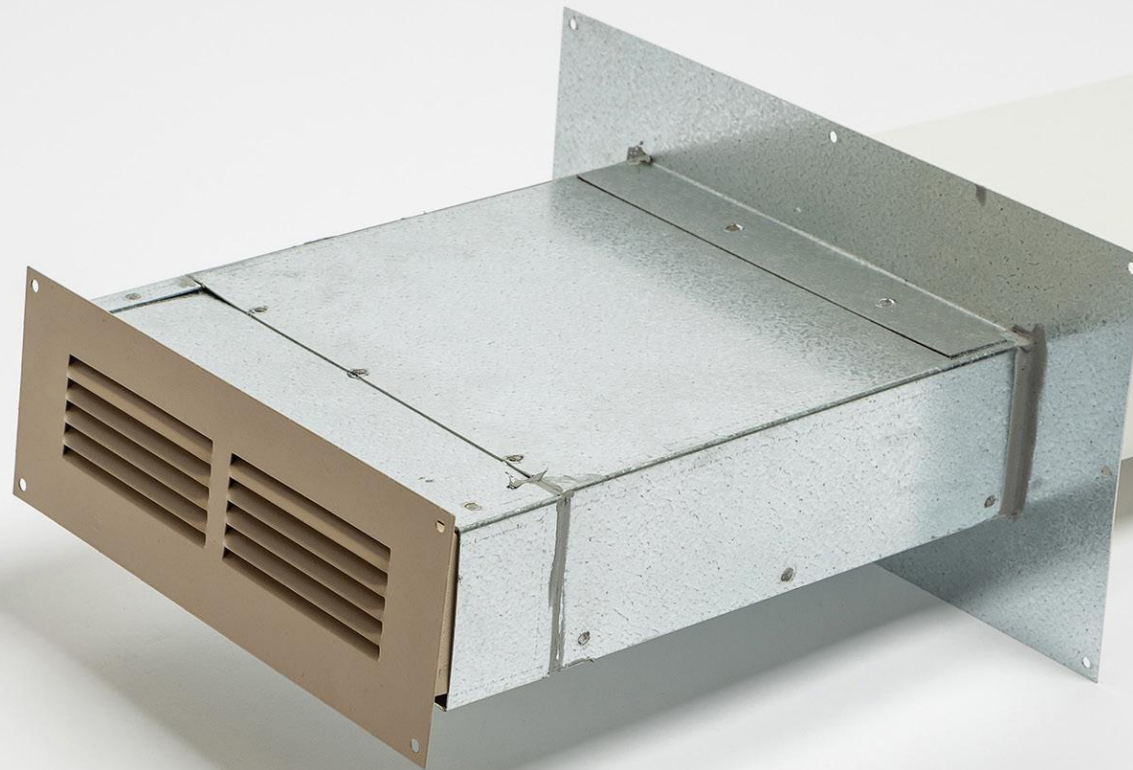

**MADE IN
BRITAIN**



EUROPEAN CLASSIFICATION A1
— NON-COMBUSTIBLE . FIRE SAFE —



DO NOT SCALE

Rytons A1® Fire-rated Retrofit Ducting Kit 204mm x 60mm with Return Grille Single Air Brick Flanged

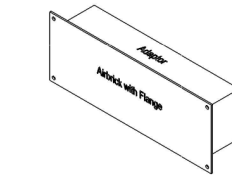
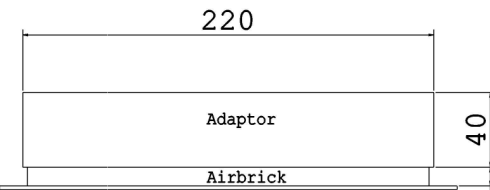
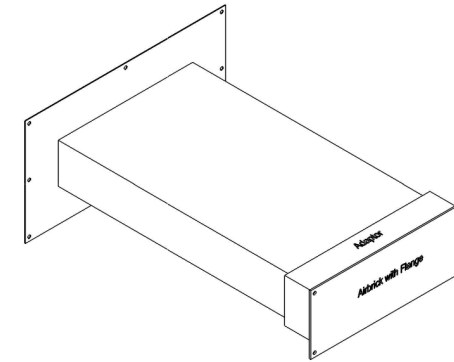
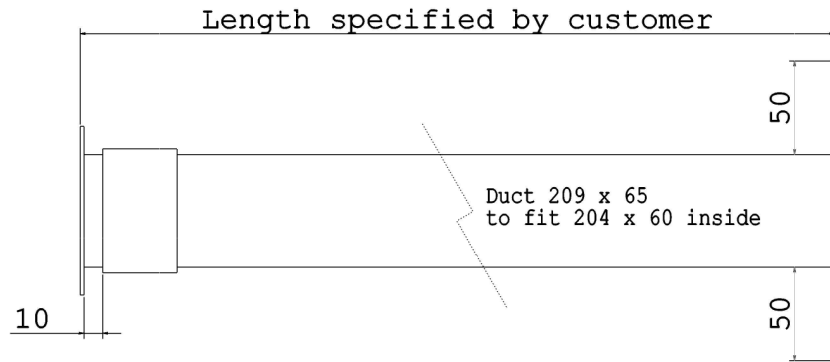

Free Area Calculation
90mm x 8mm Return Grille = 720mm ²
x10 Grilles = 7,200mm ²

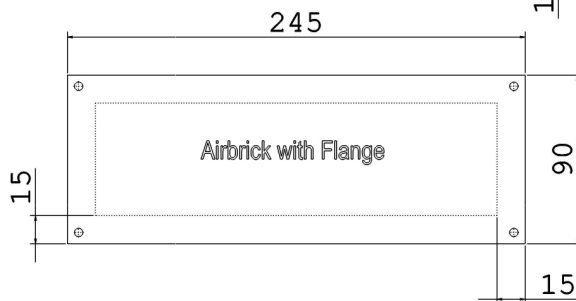

Telescopic
Up to an
extra 30mm

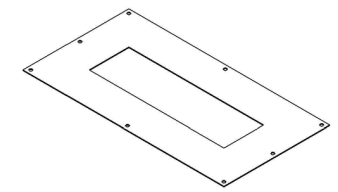
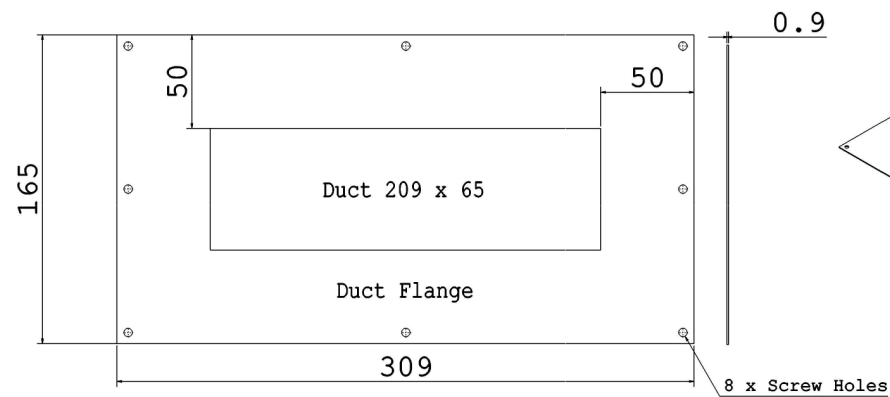
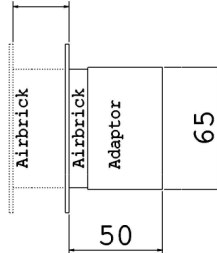

Rytons A1® Fire-rated Retrofit Ducting Kit 204mm x 60mm with Return Grille Single Air Brick Flanged

Product Code: A1RFDK204X60RGSF

Return Grille Single Air Brick Flanged 7,200mm² free area

Registered Design 6085466 Patent Approved

V4i



• Drawings are not to scale • Dimensions are in mm
• Products are hand made and have a tolerance of +/- 5%

Intellectual property of Rytons Building Products Ltd. Not to be copied, distributed or reproduced without Rytons written agreement. In case of query email admin@rytons.com.

