

Rytons A1® Fire-rated Retrofit Ducting Kit 204mm x 60mm with FlowRyt® Single Air Brick Flanged  
Custom RAL colour air brick in matt, semi-gloss or gloss finish achieving Class A2-s1, d0  
RAL1019 (Grey beige) matt finish pictured  
Registered Design 6085466  
Patent Approved  
Product Code: A1RFDK204X60FRSF

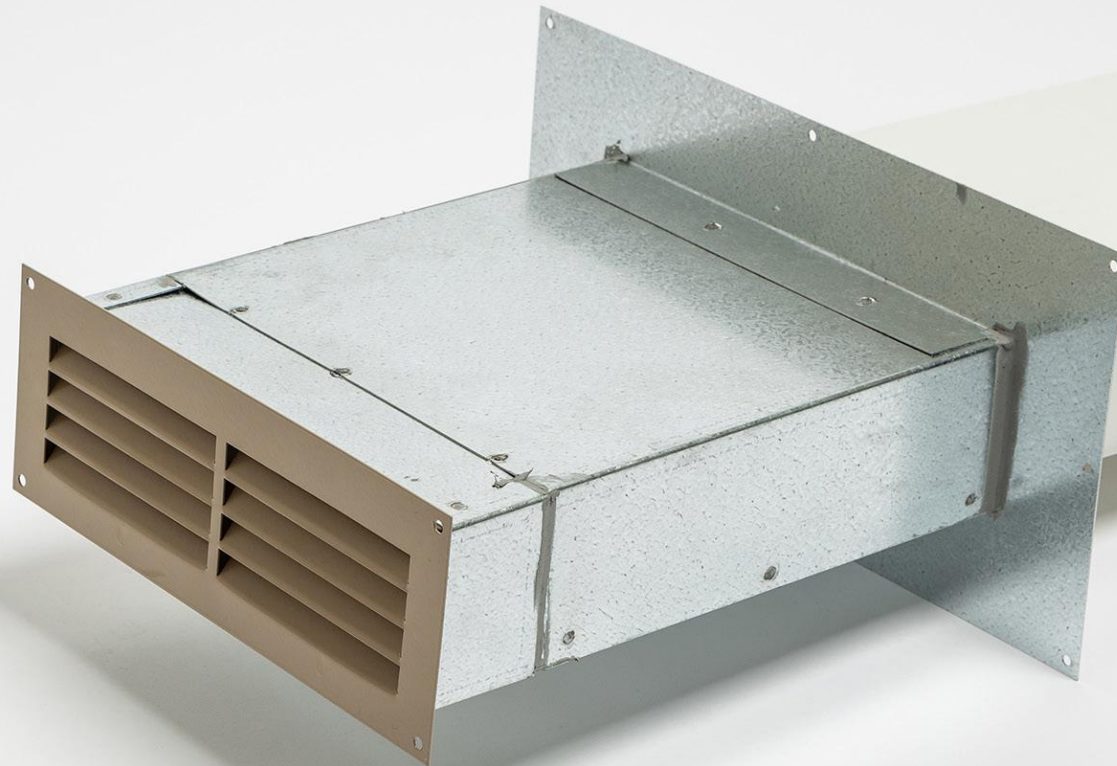

**MADE IN BRITAIN**



**EUROPEAN CLASSIFICATION A1**  
— NON-COMBUSTIBLE . FIRE SAFE —



DO NOT SCALE

Rytons A1® Fire-rated Retrofit Ducting Kit 204mm x 60mm with FlowRyt® Single Air Brick Flanged

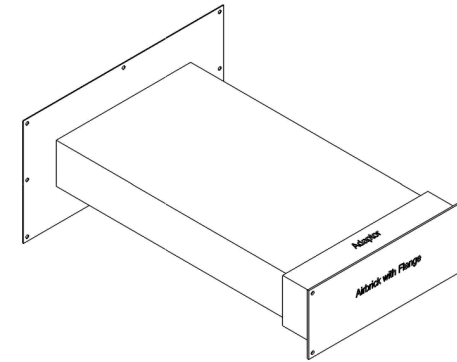
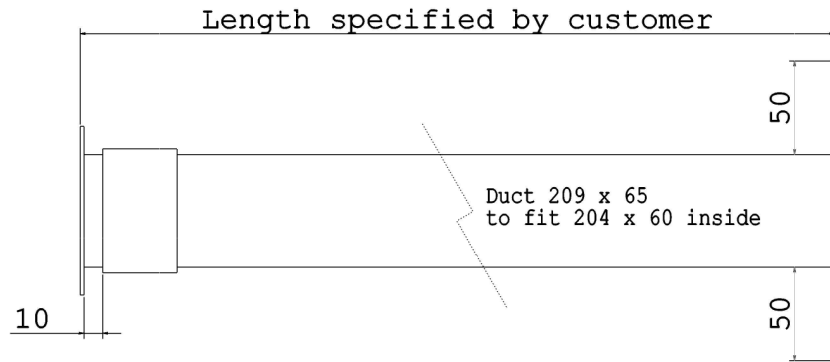

Free Area Calculation	
100mm x 10mm FlowRyt® Grille	= 1,000mm <sup>2</sup>
x8 Grilles	= 8,000mm <sup>2</sup>

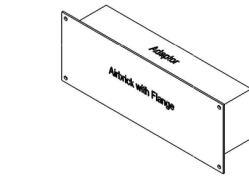
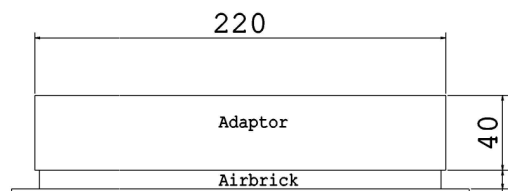

Telescopic  
Up to an  
extra 30mm

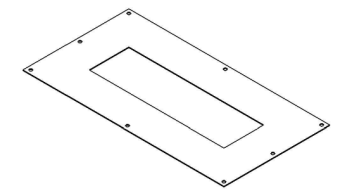
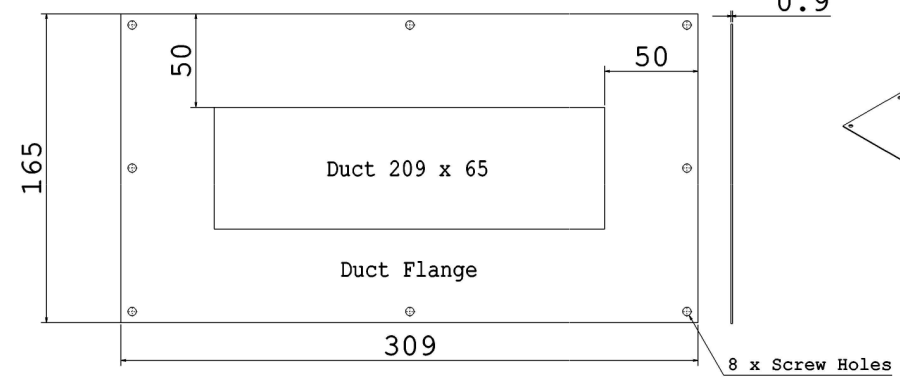
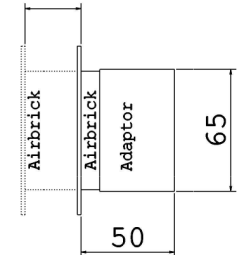
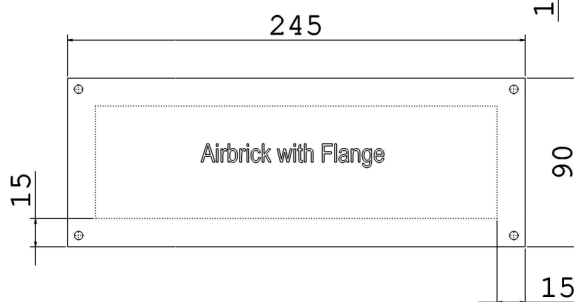

Rytons A1® Fire-rated Retrofit Ducting Kit 204mm x 60mm with FlowRyt® Single Air Brick Flanged

- Drawings are not to scale
- Dimensions are in mm
- Products are hand made and have a tolerance of +/- 5%

Product Code: A1RFDK204X60FRSF

Intellectual property of Rytons Building Products Ltd. Not to be copied, distributed or reproduced without Rytons written agreement. In case of query email admin@rytons.com.

FlowRyt® Single Air Brick Flanged  
8,000mm<sup>2</sup> free area

Registered Design 6085466  
Patent Approved

V4i

