

Rytons A1® Fire-rated Retrofit 90° Ducting Kit 204mm x 60mm with FlowRyt® Single Air Brick Flanged  
Custom RAL colour air brick in matt, semi-gloss or gloss finish achieving Class A2-s1, d0  
RAL1019 (Grey beige) matt finish pictured  
Registered Design 6085469  
Patent Approved  
Product Code: A1RF90DK204X60FRSF

**RYTONS**  
www.vents.co.uk  
*A Family Business*  
*Since 1972*

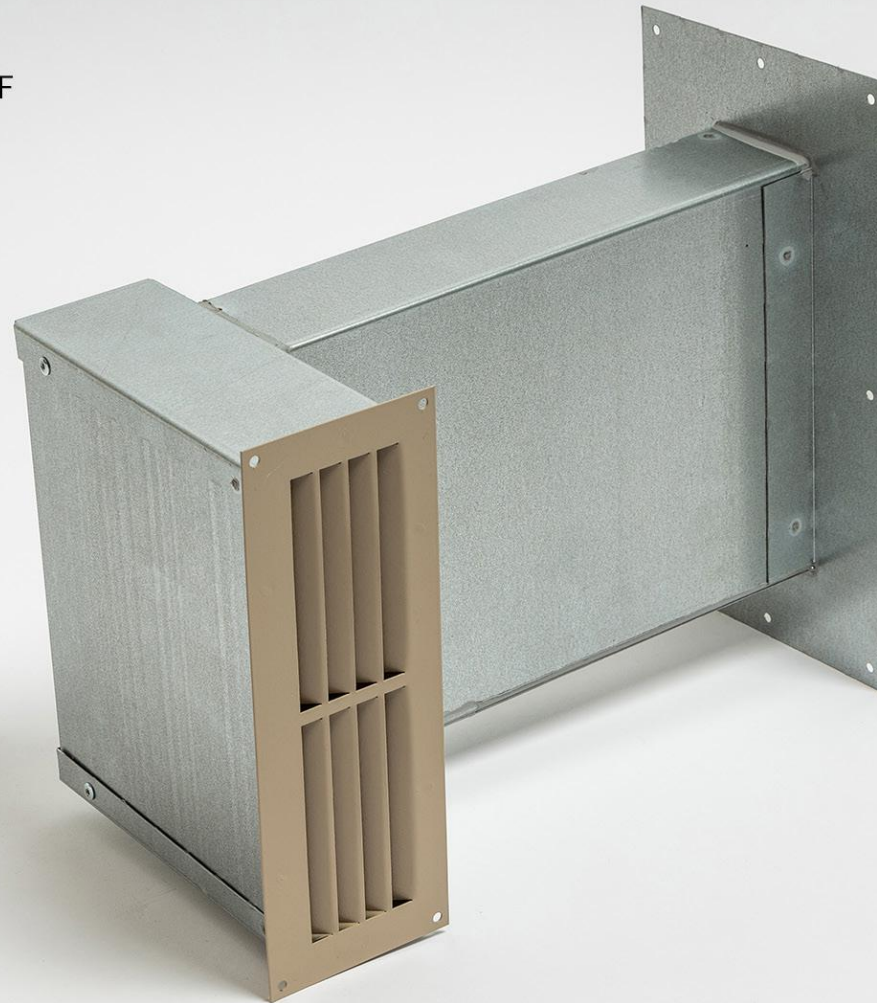

**MADE IN  
BRITAIN**



**EUROPEAN CLASSIFICATION A1**  
— NON-COMBUSTIBLE . FIRE SAFE —



DO NOT SCALE

Rytons A1® Fire-rated Retrofit 90° Ducting Kit 204mm x 60mm with FlowRyt® Single Air Brick Flanged

Length specified by customer

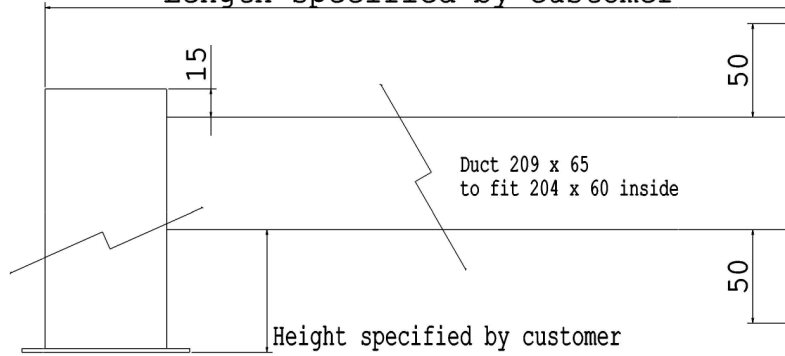

Height specified by customer

<b>Free Area Calculation</b>
100mm x 10mm FlowRyt® Grille = 1,000mm <sup>2</sup>
x8 Grilles = 8,000mm <sup>2</sup>

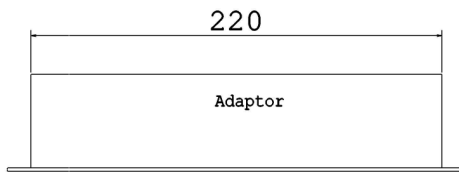
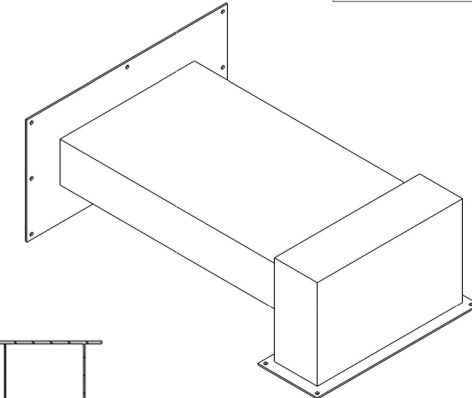

220

Adaptor

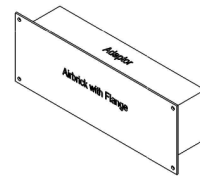

Telescopic  
Up to an  
extra 40mm

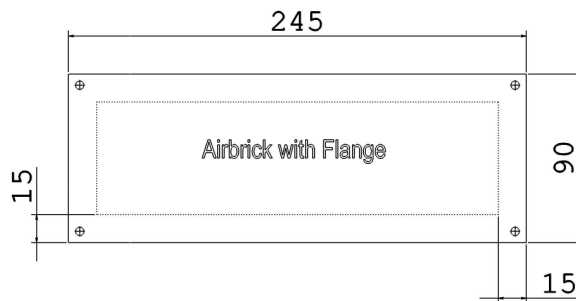

245

Airbrick with Flange

90

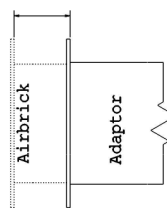

Airbrick

Adaptor

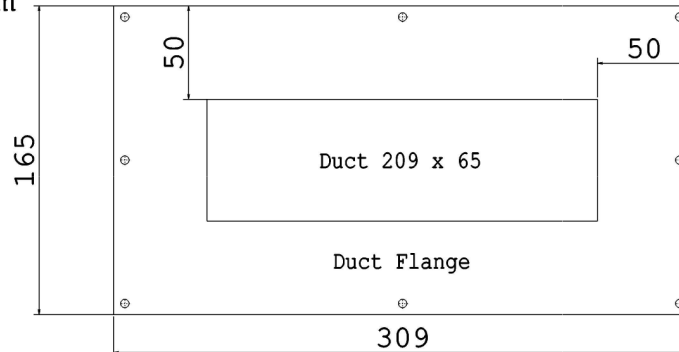

Duct 209 x 65

Duct Flange

309

0.9

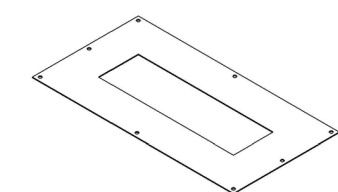

8 x Screw Holes



Rytons A1® Fire-rated Retrofit 90° Ducting Kit 204mm x 60mm with FlowRyt® Single Air Brick Flanged

Product Code:  
A1RF90DK204X60FRSF

FlowRyt® Single Air Brick Flanged  
8,000mm<sup>2</sup> free area

Registered Design 6085469  
Patent Approved

V5i



• Drawings are not to scale • Dimensions are in mm  
• Products are hand made and have a tolerance of +/- 5%

Intellectual property of Rytons Building Products Ltd. Not to be copied, distributed or reproduced without Rytons written agreement. In case of query email admin@rytons.com.

