

Rytons A1® Fire-rated Retrofit 90° Ducting Kit 110mm x 54mm with Return Grille Single Air Brick Flanged
Custom RAL colour air brick in matt, semi-gloss or gloss finish achieving Class A2-s1, d0
RAL1019 (Grey beige) matt finish pictured
Registered Design 6085462
Patent Approved
Product Code: A1RF90DK110X54RGSF

RYTONS
www.vents.co.uk
A Family Business
Since 1972

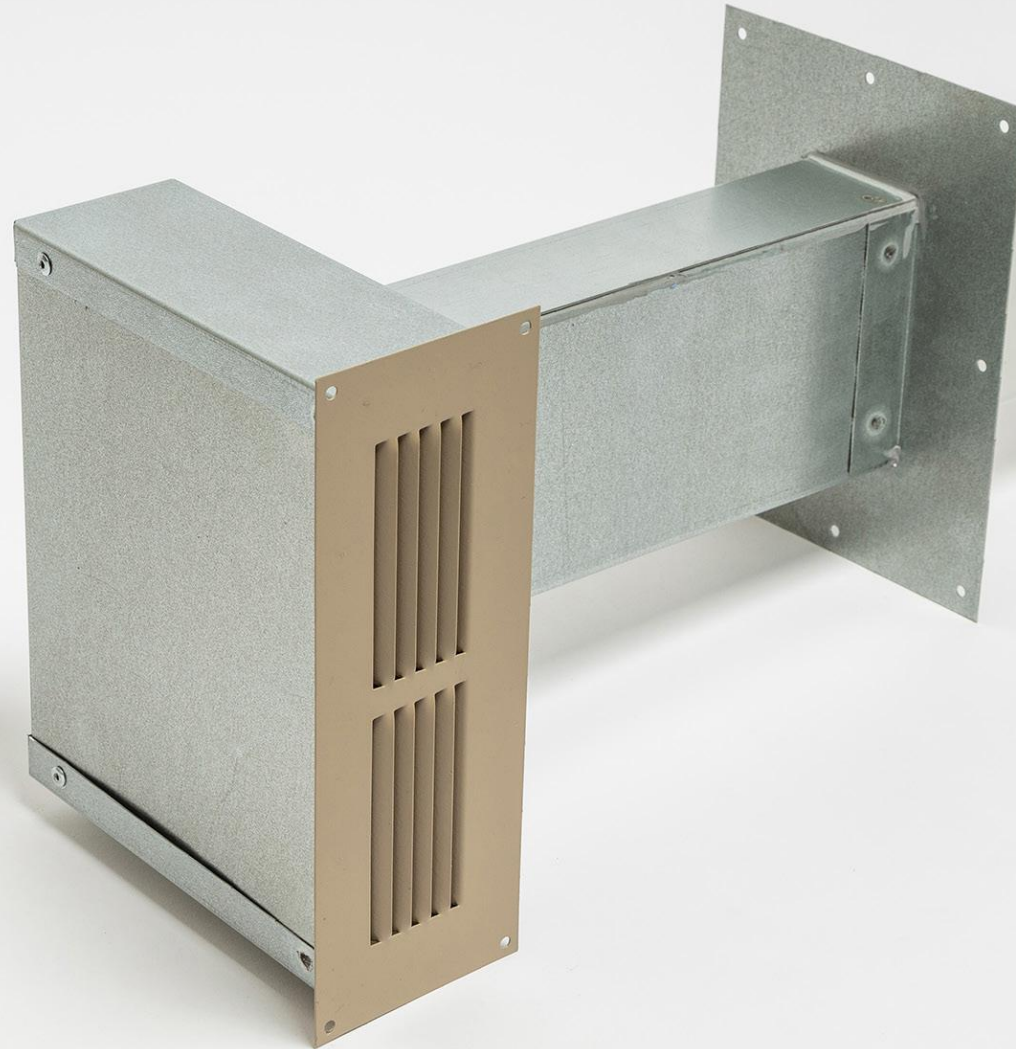

MADE IN BRITAIN



EUROPEAN CLASSIFICATION A1
— NON-COMBUSTIBLE . FIRE SAFE —



DO NOT SCALE

Rytons A1® Fire-rated Retrofit 90° Ducting Kit 110mm x 54mm with Return Grille Single Air Brick Flanged

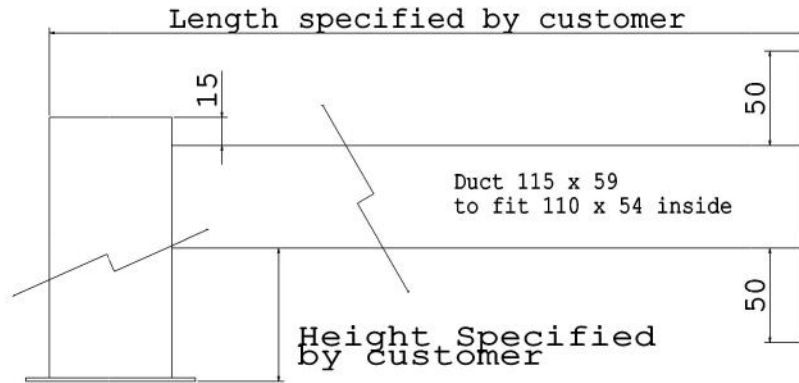

Free Area Calculation
90mm x 8mm Return Grille = 720mm ²
x10 Grilles = 7,200mm ²

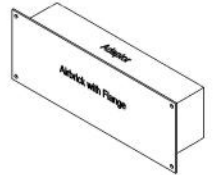
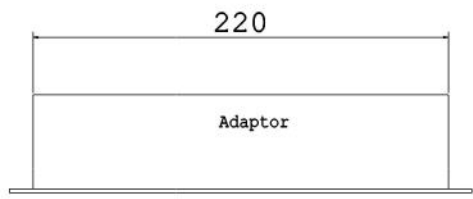
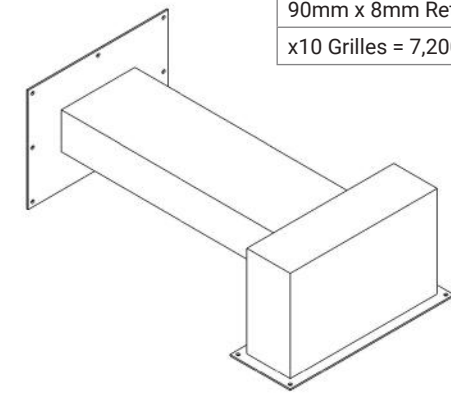

Telescopic Up to an extra 40mm

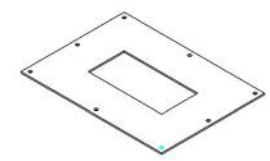
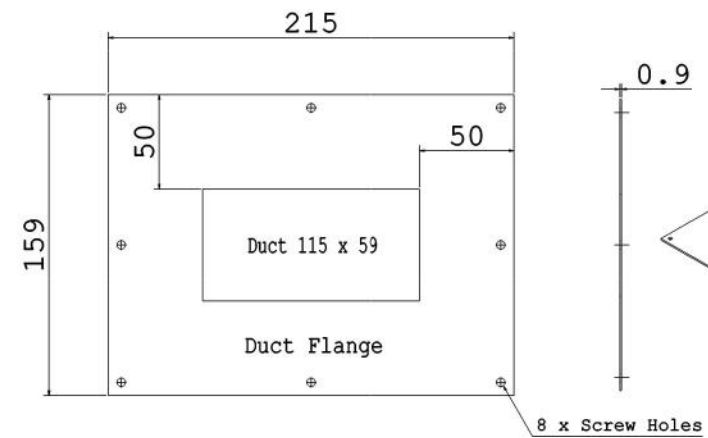
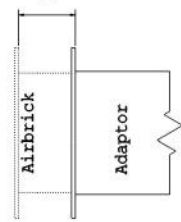
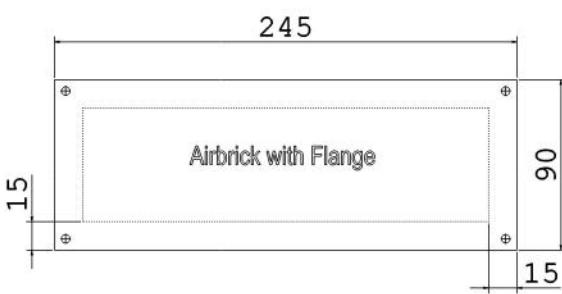

Rytons A1® Fire-rated Retrofit 90° Ducting Kit 110mm x 54mm with Return Grille Single Air Brick Flanged

- Drawings are not to scale
- Dimensions are in mm
- Products are hand made and have a tolerance of +/- 5%

Product Code: A1RF90DK110X54RGSF

Return Grille Single Air Brick Flanged
7,200mm² free area (> 90% of the duct)

Registered Design 6085462
Patent Approved

V5i



Intellectual property of Rytons Building Products Ltd. Not to be copied, distributed or reproduced without Rytons written agreement. In case of query email admin@rytons.com.