

Rytons A1® Fire-rated Retrofit 90° Ducting Kit 110mm x 54mm with FlowRyt® Single Air Brick Flanged
Custom RAL colour air brick in matt, semi-gloss or gloss finish achieving Class A2-s1, d0
RAL1019 (Grey beige) matt finish pictured
Registered Design 6085462
Patent Approved
Product Code: A1RF90DK110X54FRSF

RYTONS

www.vents.co.uk

A Family Business
Since 1972



**MADE IN
BRITAIN**



EUROPEAN CLASSIFICATION A1
— NON-COMBUSTIBLE . FIRE SAFE —



DO NOT SCALE

Rytons A1® Fire-rated Retrofit 90° Ducting Kit 110mm x 54mm with FlowRyt® Single Air Brick Flanged

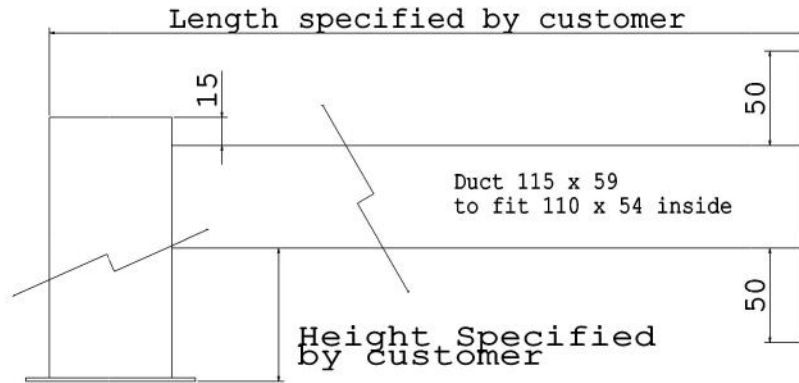

Free Area Calculation
100mm x 10mm FlowRyt® Grille = 1,000mm ²
x8 Grilles = 8,000mm ²

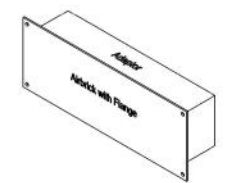
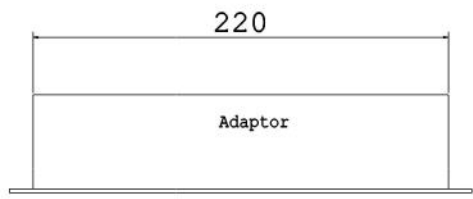
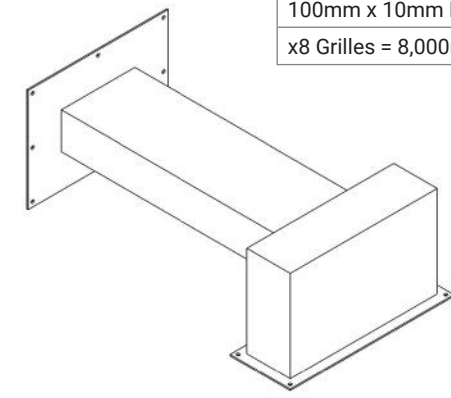

Telescopic
Up to an extra 40mm

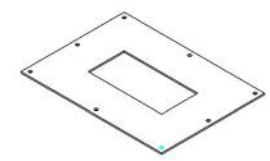
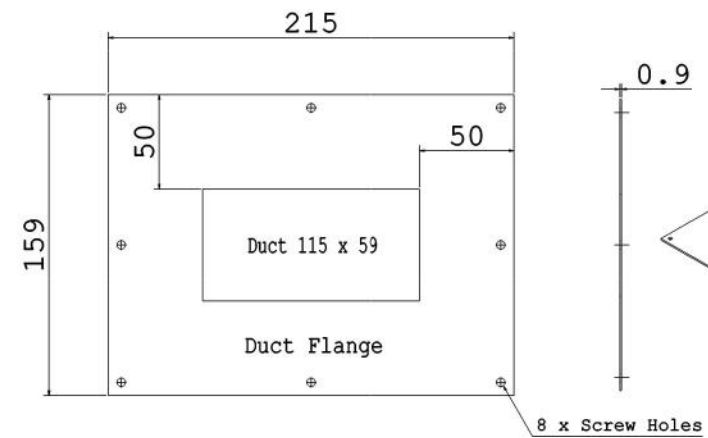
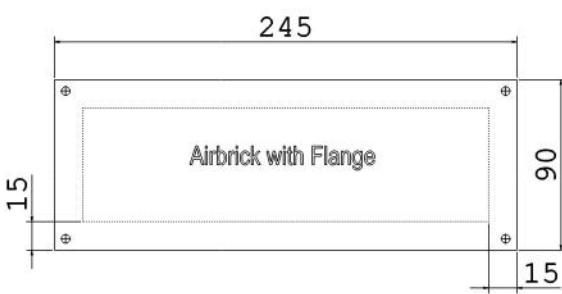
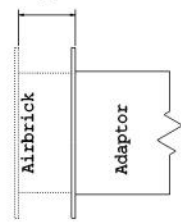

Rytons A1® Fire-rated Retrofit 90° Ducting Kit 110mm x 54mm with FlowRyt® Single Air Brick Flanged

Product Code:
A1RF90DK110X54FRSF

FlowRyt® Single Air Brick Flanged
8,000mm² free area (> 90% of the duct)

Registered Design 6085462
Patent Approved

V5i



• Drawings are not to scale • Dimensions are in mm
• Products are hand made and have a tolerance of +/- 5%

Intellectual property of Rytons Building Products Ltd. Not to be copied, distributed or reproduced without Rytons written agreement. In case of query email admin@rytons.com.

