

Rytons A1® Fire-rated Ducting Kit 100mm Dia. with Round FlowRyt® Grille  
Custom RAL colour grille in matt, semi-gloss or gloss finish achieving Class A2-s1, d0  
RAL6010 (Grass green) matt finish pictured  
Connector for 110mm x 54mm ducting  
Registered Design 6235655  
Patent Approved  
Product Code: A1DK100FRR

**RYTONS**  
www.vents.co.uk  
*A Family Business*  
*Since 1972*



**MADE IN  
BRITAIN**



EUROPEAN CLASSIFICATION A1  
NON-COMBUSTIBLE - FIRE SAFE



Rytons A1® Fire-rated Ducting Kit 100mm Dia. with Round FlowRyt® Grille  
Custom RAL colour grille in matt, semi-gloss or gloss finish achieving Class A2-s1, d0  
RAL6010 (Grass green) matt finish pictured  
Connector for 100mm dia. ducting  
Registered Design 6327475  
Patent Approved  
Product Code: A1DK100FRR

**RYTONS**  
www.vents.co.uk  
*A Family Business*  
*Since 1972*

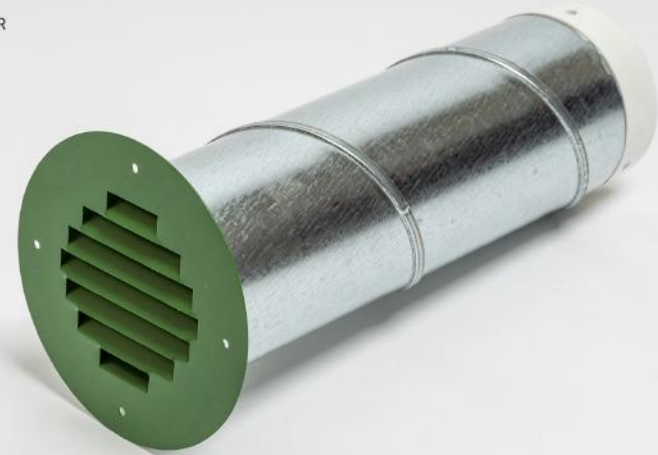

**MADE IN  
BRITAIN**



EUROPEAN CLASSIFICATION A1  
NON-COMBUSTIBLE - FIRE SAFE



DO NOT SCALE

### Rytons A1® Fire-rated Ducting Kit 100mm Dia. with Round FlowRyt® Grille

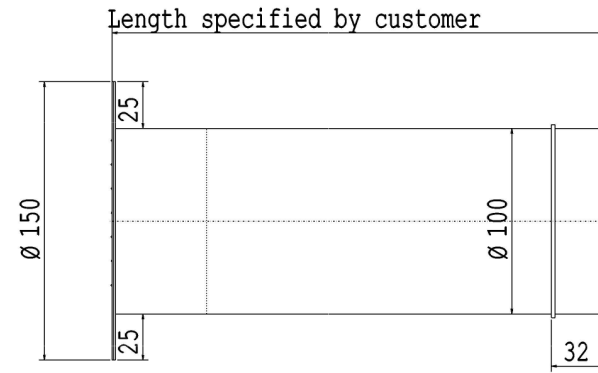
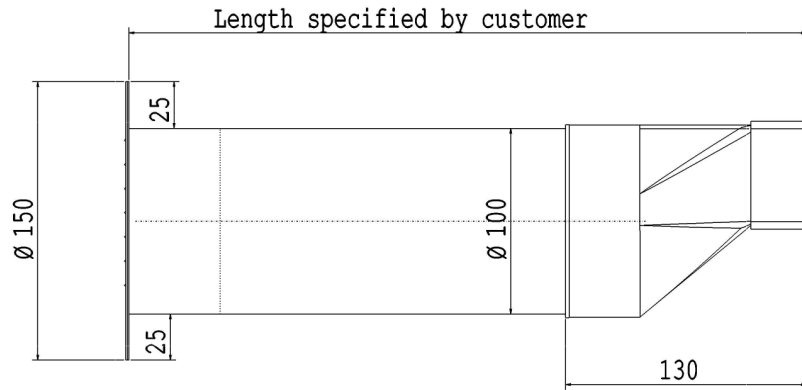
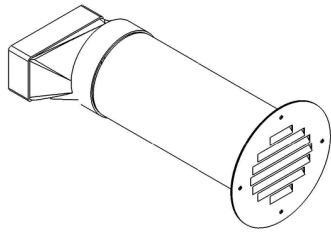

Telescopic up to an extra 40mm

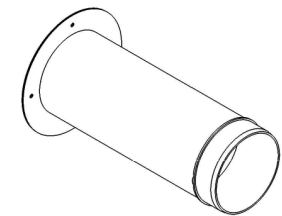
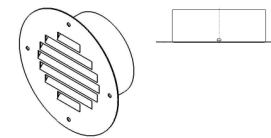
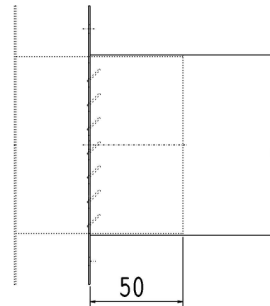
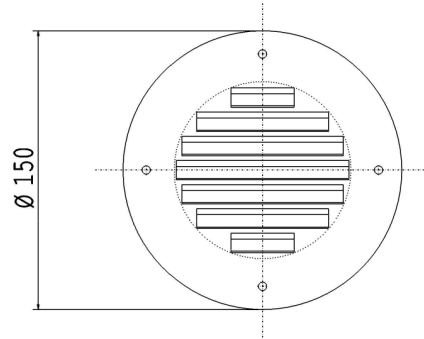

Rytons A1® Fire-rated Ducting Kit 100mm Dia. with Round FlowRyt® Grille

Product Code: A1DK100FRR

Round FlowRyt® Grille with Spigot (100mm) 4,990mm<sup>2</sup> free area

Registered Design: 6235655 & 6327475 | Patent Approved

V3ii



• Drawings are not to scale • Dimensions are in mm  
• Products are hand made and have a tolerance of +/- 5%

Intellectual property of Rytons Building Products Ltd. Not to be copied, distributed or reproduced without Rytons written agreement. In case of query email admin@rytons.com.

