

Rytons A1® Fire-rated 9x3 AirLiner®

Custom RAL colour air bricks in matt, semi-gloss or gloss finish achieving Class A2-s1, d0

Registered Design

Patent Approved

**RYTONS**

[www.vents.co.uk](http://www.vents.co.uk)

*A Family Business*

*Since 1972*

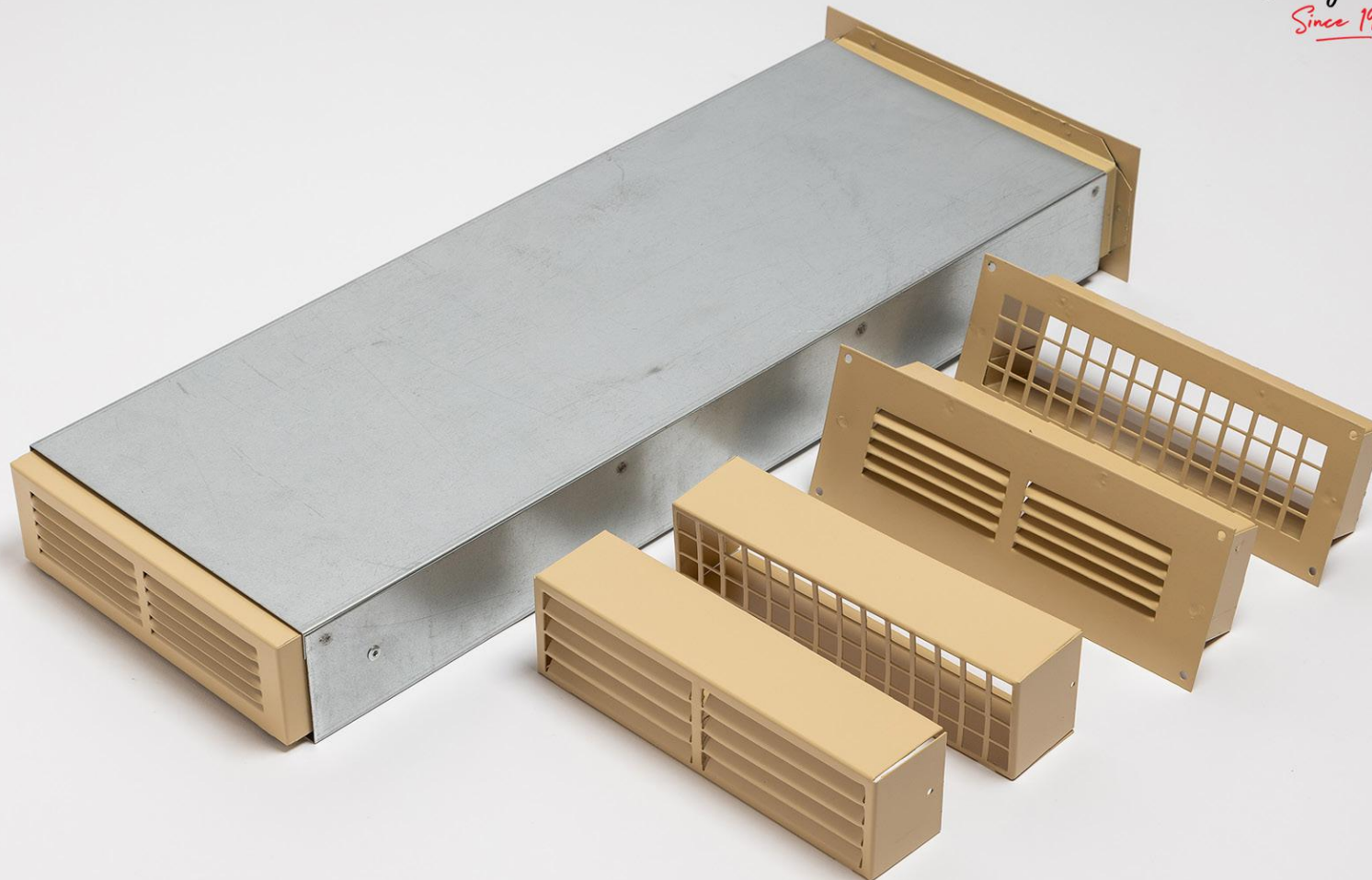

**MADE IN BRITAIN**



**EUROPEAN CLASSIFICATION A1**  
— NON-COMBUSTIBLE . FIRE SAFE —



DO NOT SCALE

# Rytons A1® Fire-rated 9x3 AirLiner®

(Available with or without Rytons A1® Fire-rated Metal Single Air Bricks)

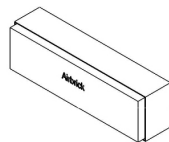
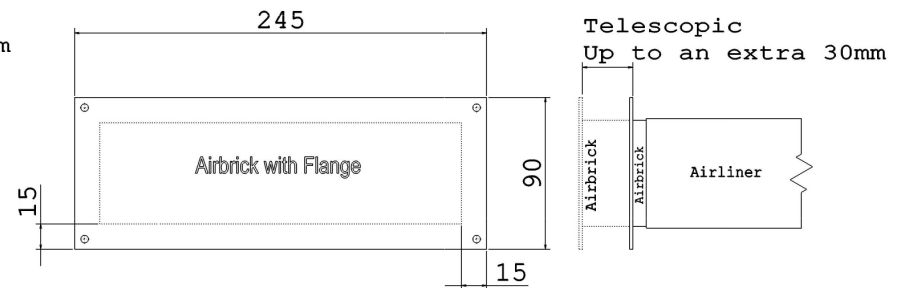
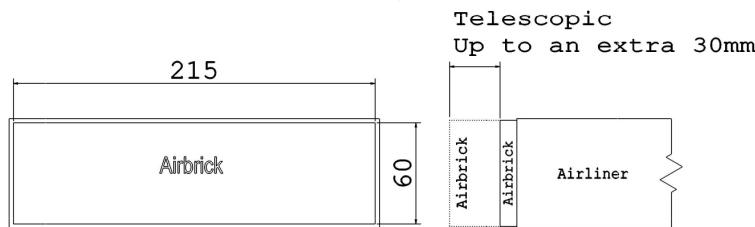
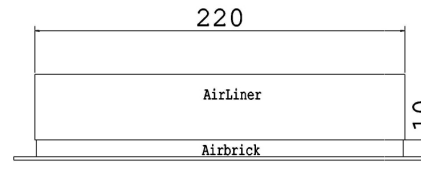
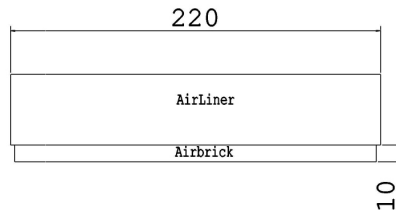
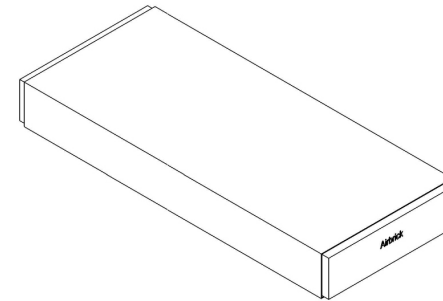
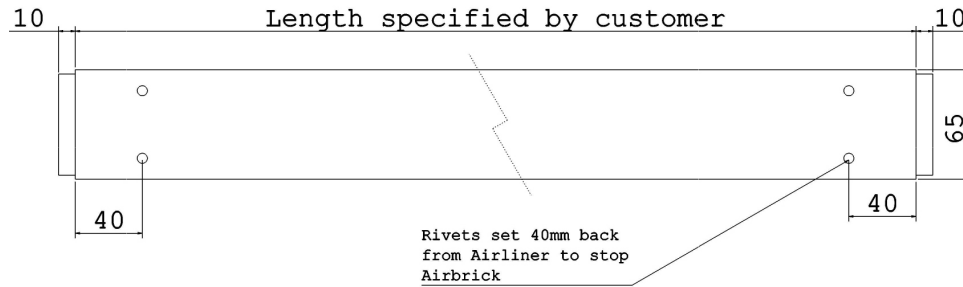

Rytons A1® Fire-rated 9x3 AirLiner®

Product Code: A1AL93

Free area is dependent on which of Rytons A1® Fire-rated Metal Single Air Bricks is used

Registered Design 6087696 & 6087697 | Patent Approved

V3i



• Drawings are not to scale • Dimensions are in mm  
• Products are hand made and have a tolerance of +/- 5%

Intellectual property of Rytons Building Products Ltd. Not to be copied, distributed or reproduced without Rytons written agreement. In case of query email admin@rytons.com.

